

# Rollers & Brackets

## RUBBER ROLLERS

STOCK NO	DESCRIPTION	LENGTH	WIDTH	HOLE SIZE	LIST
R101	BOW STOP	3"	3"	1/2"	3.00
R403	KEEL ROLLER	4"	3"	1/2"	4.45
R503	KEEL ROLLER	5"	3"	1/2"	4.95
R503A	KEEL ROLLER	5"	3"	5/8"	4.60
R504A	KEEL ROLLER	5"	3 1/2"	5/8"	7.05
R804A	KEEL ROLLER	7 1/4"	3 1/2"	5/8"	10.40
R1004A	KEEL ROLLER	10"	3 1/2"	5/8"	13.35
R1202A	KEEL ROLLER (FLAT)	12"	2 1/2"	5/8"	10.40
R1204A	KEEL ROLLER	12"	3 1/2"	5/8"	14.75
R1204AHD	KEEL ROLLER HEAVY DUTY	12"	3 3/4"	5/8"	17.25
R1804A	KEEL ROLLER	18"	3 3/4"	5/8"	26.75
R204	H-ROLLER	2"	4"	1/2"	14.40
R404	WOBBLE ROLLER	4"	4"	7/8"	8.60
R22V	V-BLOCK	2"	2"	1/2"	3.00
R33V	V-BLOCK	3"	3"	1/2"	8.40
R33VJB	JOHN BOAT BOW BLOCK	3"	3"	1/2"	10.10
R90802	WOBBLE ROLLER FITS SHORELINE (DIA.)	4 1/4"	3 1/4"	7/8"	18.40
R530	WOBBLE ROLLER FITS CONTINENTAL	5" (DIA.)	3"	3/4"	9.95
R804AHD	KEEL ROLLER HEAVY DUTY	7 1/4"	3 1/2"	5/8"	12.95



R101



R33V



R503



R1204A



R1202A



R404



R530

## 8" POLYMER ROLLER

MADE OF IMPACT RESISTANT SPACE AGE POLYMER THAT WILL NOT MARK YOUR BOAT.

STOCK NO	LIST
80-50115	13.98



8" KEEL ROLLER

## POLYMER BELL ROLLERS

MADE OF SPACE AGE POLYMER THAT WILL NOT MARK YOUR BOAT. COMPLETE WITH BOLTS, WASHERS AND NUT.

STOCK NO	DESCRIPTION	LIST
80-50076	3" CENTER BOW ROLLER ASSEMBLY - YELLOW	12.25
80-50077	4" CENTER BOW ROLLER ASSEMBLY - YELLOW	16.59
80-50078	3" CENTER BOW ROLLER ASSEMBLY - BLACK	5.50
80-50079	4" CENTER BOW ROLLER ASSEMBLY - BLACK	8.50

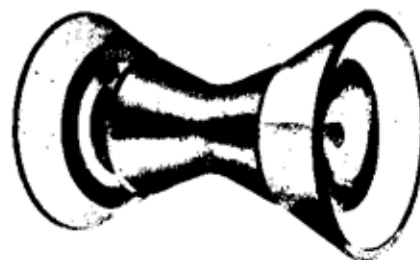

## POLYMER KEEL PADS

IMPACT RESISTANT SPACE AGE POLYMER  
THAT MOUNTS TO 3" WIDE TUBE OR CHANNEL.  
MOUNTS WITH SCREWS OR BOLTS.

STOCK NO	DESCRIPTION	LIST
80-50080	3" X 12" - BLACK	5.45
80-50081	3" X 12" - YELLOW	7.59



## STOLTZ SUPER ROLLERS

### ROLLERS - POLYURETHANE

WILL OUTLAST ORDINARY RUBBER ROLLERS MANY TIMES. WILL NOT  
MARK YOUR BOAT. SHOCK ABSORBING. EXTREMELY CUT RESISTANT.  
NO BUSHINGS TO POP OUT.

STOCK NO	DESCRIPTION	LENGTH	WIDTH	HOLE SIZE	LIST
RP30	ANCHOR ROPE ROLLER	2 1/4"	2 15/16"	1/2"	10.55
RP32	END CAP ROLLER	1 1/2"	3 3/4"	5/8"	5.45
RP33	BOW STOP	3"	3"	1/2"	8.00
RP443434*	3" ULTIMATE BOW STOP	6 1/2"	5 1/4"	1/2"	32.20
RP443444*	4" ULTIMATE BOW STOP	7 1/2"	5 1/4"	1/2"	32.70
RP444	4" CENTER ROLLER	4"	3 1/8"	1/2"	10.15
RP443	3" CENTER ROLLER	3"	3 1/8"	1/2"	9.95
RP434	END BELL	2"	5 1/4"	1/2"	10.45
RPV2	2" V BLOCK	2"	2"	1/2"	7.65
RP3	3" V-BLOCK	3"	3"	1/2"	9.15
RP404	4" V-BLOCK	4"	4"	1/2"	16.20
RP4	KEEL ROLLER	4"	2"	5/8"	11.55
RP5	KEEL ROLLER	5"	3"	5/8"	10.75
RP504	KEEL ROLLER	5"	3 3/4"	5/8"	15.90
RP7	KEEL ROLLER	7"	3 3/4"	5/8"	23.90
RP8	KEEL ROLLER	8"	3 3/4"	5/8"	22.60
RP10	KEEL ROLLER	10"	3 3/4"	5/8"	26.65
RP12	KEEL ROLLER	12"	3 3/4"	5/8"	28.60
RP212	KEEL ROLLER (FLAT)	12"	2 1/2"	5/8"	26.50
RP18	KEEL ROLLER	18"	3 3/4"	5/8"	44.95
RP42	H-ROLLER (LG)	2"	4"	1/2"	12.95
RP6X2	JACK WHEEL	6"	2"	1/2"	26.95
RP44	WOBBLE ROLLER	4"	4"	3/4"	18.45
RP36	WOBBLE ROLLER FITS EZ LOADER	3"	4"	1"-1 1/16"	17.75
RP3112	KEEL SKID PAD	12"	3"	1/4"	12.45

\*COMES COMPLETE WITH BOLT, NUT & WASHERS.

### POLYURETHANE BOW STOPS

STOCK NO	FITS	HOLE SIZE	LIST
RPWC5A	JET SKI & WAVE RUNNER	1/2"	16.00
RPWC6	SUPER JET & WAVE RUNNER	1/2"	13.80
RPWC7	WINCH ADAPTER	1/2"	15.85

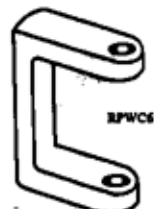
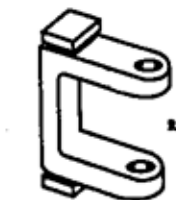
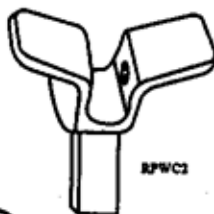

1" BOW STOP ROLLER



3" V" BOW STOP



4" V" BOW STOP

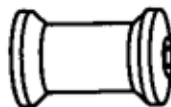

4" KEEL ROLLER

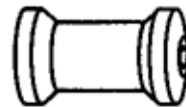

6" KEEL ROLLER

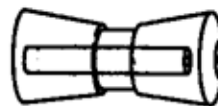

8" KEEL ROLLER

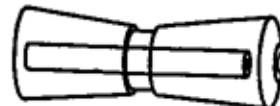

10" KEEL ROLLER

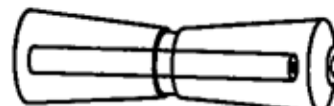

12" KEEL ROLLER

### WAVE RUNNER BOW PIN

ZINC PLATED FOR RUST RESISTANCE

STOCK NO	LIST
95-30005	4.45

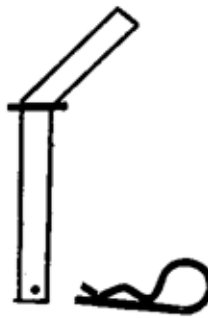

### SNAPPER PIN

POPULAR QUICK CONNECT AND DISCONNECT PIN. PIN DIA. 1/4", USEABLE LENGTH 2 1/4" (A), CLEARANCE 1 1/4" (B).

STOCK NO	LIST
12-2312807	1.80

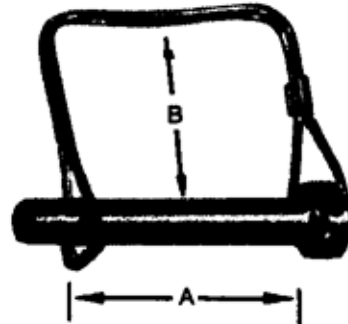

### ROLLER BRACKETS

GALVANIZED

STOCK NO	SIZE	LIST
46-RB5	FOR 5" ROLLER	9.40
46-RB8	FOR 8" ROLLER	11.85
46-RB10	FOR 10" ROLLER	13.50
46-RB12	FOR 12" ROLLER	14.40
46-RB2S	SPLIT BRACKET (PAIR)	7.65

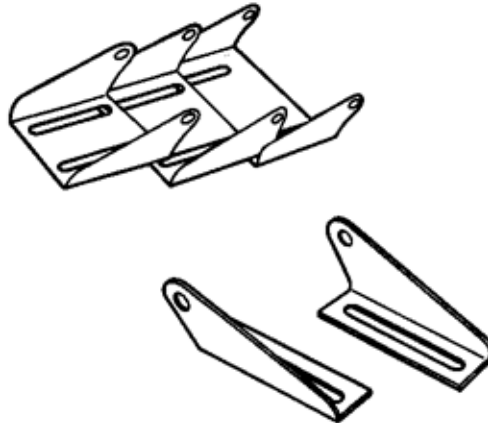

### TONGUE ROLLER BRACKETS

USED WHEN MORE BOW SUPPORT IS NEEDED. HOT DIPPED GALVANIZED FINISH. SOLD IN PAIRS ONLY, WITHOUT HARDWARE OR ROLLER.

STOCK NO	LIST
46-TRB	12.25

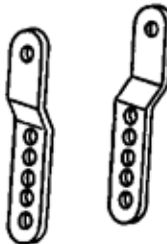

### PAL NUTS

SOLD INDIVIDUALLY OR IN BAGS OF 50.

STOCK NO	QTY	SHAFT DIA.	LIST
65-PN12	1	1/2"	.30
65-PN12B	50	1/2"	17.95
65-PN58	1	5/8"	.35
65-PN58B	50	5/8"	17.95



### COTTER PINS

STOCK NO	SIZE	QTY	LIST
66-CP BULK	1/8" X 2"	1	.28
66-CP100	1/8" X 2"	100	7.65

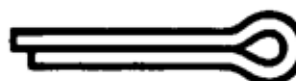

## SWIVEL BOW BRACKET

SOLD AS A PAIR.

STOCK NO	LIST
22-43680-81	12.65

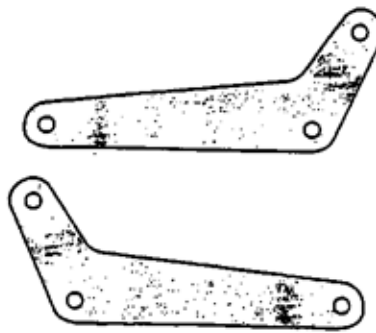

## ROLLER SHAFTS

ZINC PLATED. FOR USE WITH PAL NUTS.

STOCK NO	DIA.	LENGTH	FOR ROLLER	LIST
46-RS42	1/2"	5 1/2"	R403	1.27
46-RS52	1/2"	6 1/2"	R503	1.37
46-RS82	1/2"	9 1/2"	R803	1.60
46-RS122	1/2"	13 1/2"	12" ROLLERS WITH 1/2" HOLE	1.90
46-RS5	5/8"	6 1/2"	R504A, R503A, RP5, RP504	1.90
46-RS8	5/8"	9 1/2"	R804A, RP8	2.15
46-RS10	5/8"	11 1/2"	R1004A, RP10	2.25
46-RS12	5/8"	13 1/2"	R1204A, R1202A, RP12, R1204AHD	2.50

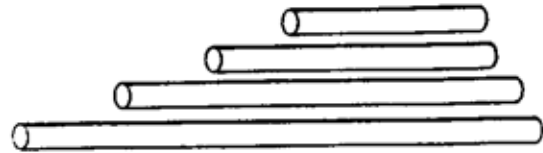

## ROLLER SHAFTS - DRILLED

ZINC PLATED. FOR USE WITH COTTER PINS.

STOCK NO	DIA.	LENGTH	FOR ROLLER	LIST
46-RS5D	5/8"	6 1/2"	R503A, R504A, RP5, RP504	4.85
46-RS8D	5/8"	9 1/2"	R804A, RP8	5.60
46-RS12D	5/8"	13 1/2"	R1202A, R1204A, RP12, R1204AHD	6.70
46-RS18D	5/8"	19 1/2"	R1804A, RP18	10.40

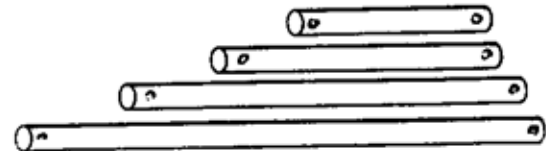

## STAINLESS STEEL - ROLLER SHAFTS

DRILLED FOR USE WITH COTTER PINS.

STOCK NO	DIA.	LENGTH	FOR ROLLER	LIST
95-RS12SS	5/8"	13 1/2"	R1204A, R1202A, RP12	9.95
95-RS8SS	5/8"	9 1/2"	R804A, RP8	8.75

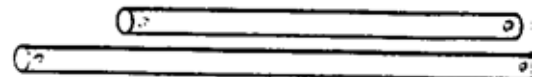

## ROLLER BRACKET ASSEMBLY

INCLUDES ROLLER BRACKET, SHAFT AND PAL NUTS, RUBBER OR POLY ROLLERS.

STOCK NO	SIZE	LIST
95-RBA5R	5" ROLLER ASSEMBLY - RUBBER	15.50
95-RBA8R	8" ROLLER ASSEMBLY - RUBBER	23.75
95-RBA10R	10" ROLLER ASSEMBLY - RUBBER	27.95
95-RBA12R	12" ROLLER ASSEMBLY - RUBBER	29.95
95-RBA5P	5" ROLLER ASSEMBLY - POLY	22.50
95-RBA8P	8" ROLLER ASSEMBLY - POLY	39.50
95-RBA10P	10" ROLLER ASSEMBLY - POLY	44.85
95-RBA12P	12" ROLLER ASSEMBLY - POLY	48.85

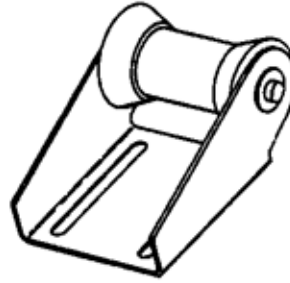

## TONGUE ROLLER ASSEMBLY

USED WHEN MORE BOW SUPPORT IS NEEDED. COMES COMPLETE WITH ALL NECESSARY HARDWARE FOR TONGUE MOUNTING.

STOCK NO	DESCRIPTION	LIST
95-TRA2P	2" TONGUE, 4" POLY	22.31
95-TRA2R	2" TONGUE, 4" RUBBER	14.95
95-TRA3P	3" TONGUE, 5" POLY	27.75
95-TRA3R	3" TONGUE, 5" RUBBER	18.75

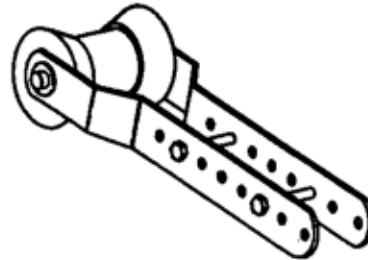

## H-ROLLERS

(SOLD IN PAIRS)  
GALVANIZED METAL FRAME ("U" BOLTS AND PLATES NOT INCLUDED). RUBBER OR POLY ROLLERS.

STOCK NO	DESCRIPTION	LIST
95-HR4R	RUBBER ROLLERS	135.00
95-HR4P	POLY ROLLERS	170.00

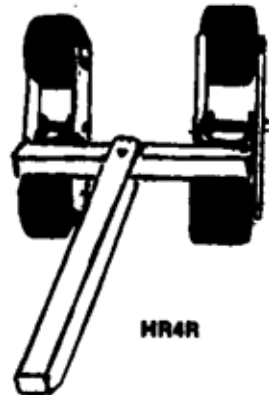

HR4R

## ROLLER BUNKS

(SOLD IN PAIRS)  
ROLLER BUNKS PROVIDE A QUICK, EASY, AND INEXPENSIVE WAY TO UPGRADE BUNK STYLE TRAILERS TO ROLLERS. 4' GALVANIZED BUNKS.

STOCK NO	LENGTH	LIST
23-27700	4'	115.00
23-27710	5'	132.00



## CHOCK POST-GALVANIZED

STOCK NO	PIPE LENGTH	DIA	DESCRIPTION	LIST
95-CP1	12"	1 1/2"	ROUND	10.50
95-CP2	16"	1 1/2"	ROUND	14.70
95-CP3	12"	1 1/2"	SQUARE	10.50
95-CP5	16"	1 1/2"	SQUARE	13.20
95-CP6	12"	1 1/2"	ROUND (FOR 4"X4" WOOD BUNK)	10.40



## BUNK BRACKET

SLOTTED FOR EASE IN VERTICALLY MOUNTING.  
FORMED OF HEAVY GAUGE STEEL FOR LONG LIFE.  
GALVANIZED.

STOCK NO	O.A. LENGTH	SLOT SIZE	LIST
46-20204	9 1/2"	4" X 1/2"	6.85
46-20206	12 1/2"	7 7/8" X 1/2"	9.35

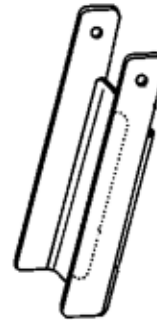

## SWIVEL TOP BUNK BRACKET

SLOTTED FOR EASE IN VERTICALLY MOUNTING 2 X 4'S,  
FORMED OF HEAVY GAUGE STEEL FOR LONG LIFE.  
COMES WITH TOP ANGLE BRACKET. USES 3/8" X 1"  
BOLT TO MOUNT PIECES TOGETHER (NOT INCLUDED).

STOCK NO	LENGTH	SLOT SIZE	LIST
46-20210	8"	9/16"	7.40
46-20212	10"	9/16"	8.80
46-20214	12"	9/16"	10.25



## HEAVY DUTY SWIVEL BRACKET

GALVANIZED HEAVY DUTY BRACKET IS DOUBLE  
SLOTTED FOR USE IN HEAVIER LOAD APPLICATIONS.  
USES 1/2" BOLTS (NOT INCLUDED) TO MOUNT TO  
TOP ANGLE. MUST ORDER LEFT HAND AND RIGHT HAND  
FOR SET.

STOCK NO	LENGTH	SLOT SIZE	LIST
22-86135R	10"	9/16"	7.09
22-86135L	10"	9/16"	7.09
22-86134R	12"	9/16"	10.45
22-86134L	12"	9/16"	10.45



## TOP ANGLE

TOP ANGLE IS USED WITH BUNK BRACKETS.  
GALVANIZED FINISH. FITS THE FOLLOWING  
BRACKETS: 20210, 20212, 20214.

STOCK NO.	LIST
46-TOP ANGLE	1.70

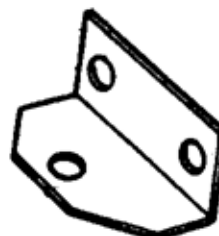

## HEAVY DUTY TOP ANGLE

FITS BRACKETS 22-86135 AND 22-86134.

STOCK NO	LIST
22-44006	2.45



## BUNK BRACKET

### SUBMERSIBLE TRAILERS

DESIGNED TO MOUNT ON 3" WIDE TUBE CROSS MEMBER. HOLDS 2" TO 4" WIDE WOOD TO SUPPORT BOAT HULL. SOLD IN SET OF TWO.

STOCK NO	DESCRIPTION	LIST
46-62100	GALVANIZED 8" H X 5" W	15.25
46-62100A	ALUMINUM 8" H X 5" W	21.35
46-62100AS	ALUMINUM 6 1/4" X 5" W	17.15
46-62100S	GALVANIZED 6 1/4" H X 5" W	14.60
46-62100XL	GALVANIZED 10" H X 4 7/8" W	19.95



## FLAT BUNK BRACKETS

USED ON PERSONAL WATERCRAFT TRAILERS AND OTHER LIGHTWEIGHT APPLICATIONS.

STOCK NO	DESCRIPTION	LIST
22-44009L	LEFT SIDE BRACKET	7.50
22-44009R	RIGHT SIDE BRACKET	7.50

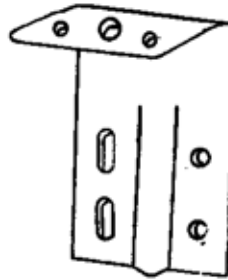

## FLAT WOOD BUNK

USED WITH SWIVEL TOP BUNK BRACKET.

STOCK NO	SIZE	LIST
14-FB2448	2" X 4" X 4'	12.30
14-FB2460	2" X 4" X 5'	20.05
14-FB2472	2" X 4" X 6'	21.00
14-FB2481	2" X 4" X 81"	23.00
62150	2" X 6" X 8'	29.00
62151	2" X 6" X 10'	34.00
62152	2" X 6" X 14'	46.00

